

CUSTOMER APPROVAL:
(Sign Only if 100% Accurate)

By: _____

Date: _____



CUSTOMER NOTES: (Please Record & Number
All Changes In this Box Only)

Clear Door Opening Height
83 1/8"

Clear Door Opening Width
46 11/16"

HOLDING BEAMS:
YES

COLOR:
CLEAR

SHERWIN WILLIAMS COMPANY

SO # 0056610-001 (CUSTOMER PO # USP00800338)
TX9200 PG BP, (O-SX-SX-O), 1" GLASS, CONT. T'HOLD

TAG AS: SW WICHITA

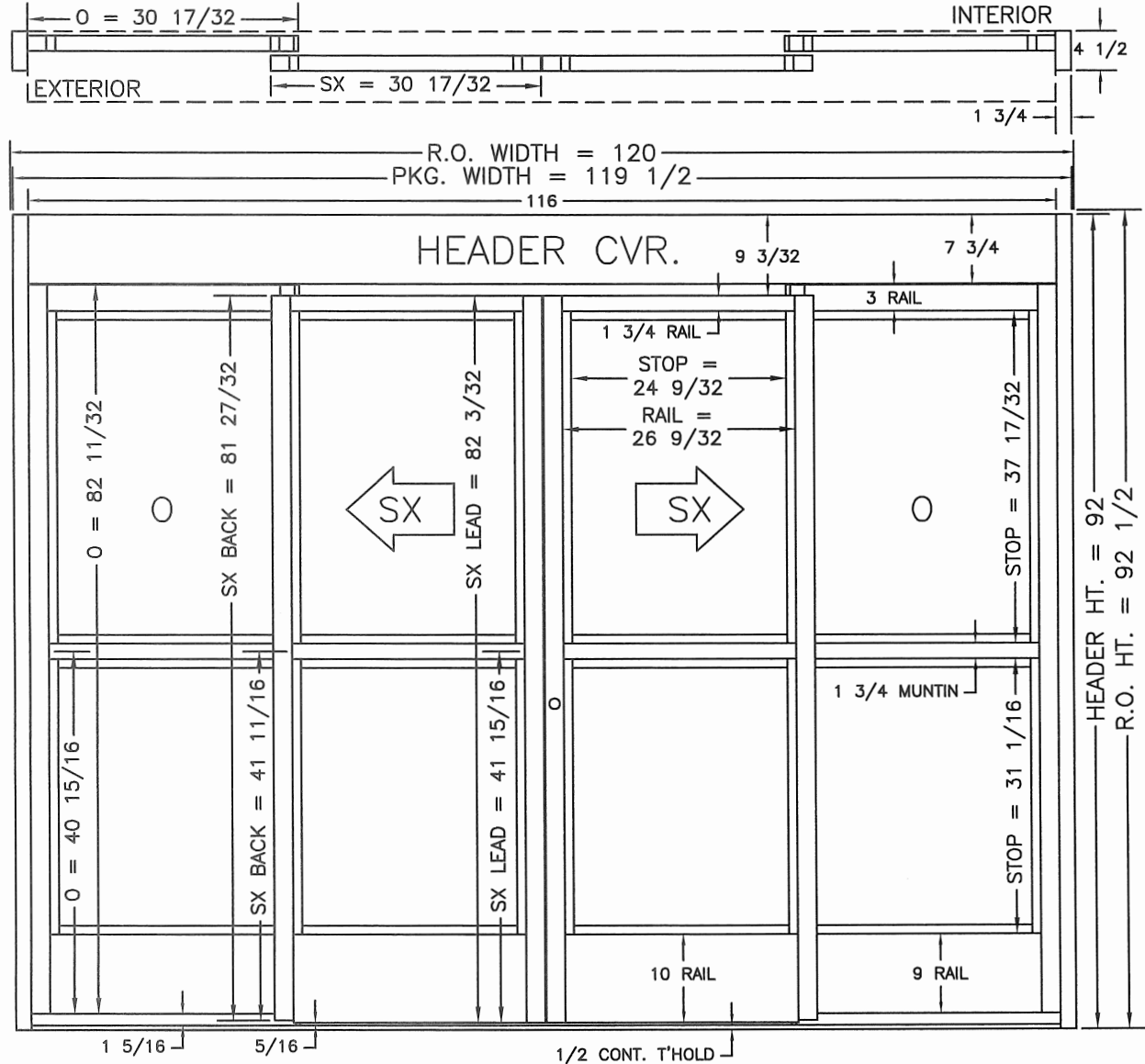

For Mounting Heights To 10' (environmental separation) and 8' (insect control)

STANDARD CONSTRUCTION

- 14" high x 15" deep
- 1/2 hp three speed motor(s)
- Factory installed fan speed switch
- White or black aluminum exterior cover (Optional: Custom Color or Stainless)
- Wall & Top Mounting
- Optional: Filter (washable)



Berner International Corporation certifies that the air curtains shown herein are licensed to bear the AMCA Seal. The ratings shown are based on tests and procedures performed in accordance with AMCA Publication 211 and comply with the requirements of the AMCA Certified Ratings Program. Rated data shown is for base (unheated) units. The AMCA Certified Ratings Seal applies to airflow rate, average outlet velocity, outlet velocity uniformity, velocity projection and power rating at free delivery only.

5 Year Limited Warranty



MODEL	Nozzle Width (in)	Max Vel. at Nozzle (fpm)	Avg. Outlet Vel. (fpm)	Air Volume (cfm)	Outlet Vel. Uniformity	Power Rating (kW)	Motor(s) @ hp	Net Wt. (lbs)
CHD10-1036A	36.00	3,284	2,062	1,804	73%	0.78	1 @ 1/2	50
CHD10-1042A	42.00	3,592	1,748	1,784	54%	0.74	1 @ 1/2	52
CHD10-1048A	48.00	3,614	1,515	1,768	62%	0.75	1 @ 1/2	53
CHD10-1060A	60.00	3,319	1,184	1,726	48%	0.73	1 @ 1/2	54
CHD10-2060A	60.00	3,711	1,801	2,626	74%	1.21	2 @ 1/2	70
CHD10-2072A	72.00	3,284	2,062	3,608	73%	1.56	2 @ 1/2	84
CHD10-2084A	87.00	3,592	1,687	3,568	54%	1.49	2 @ 1/2	104
CHD10-2096A	99.00	3,614	1,470	3,536	62%	1.49	2 @ 1/2	106
CHD10-3096A	99.00	3,284	1,841	4,430	73%	1.99	3 @ 1/2	120
CHD10-2108A	111.00	3,319	1,295	3,494	48%	1.48	2 @ 1/2	107
CHD10-3108A	111.00	3,284	2,006	5,412	73%	2.34	3 @ 1/2	150
CHD10-2120A	116.25	3,319	1,222	3,452	48%	1.47	2 @ 1/2	108
CHD10-3120A	116.25	3,284	1,908	5,392	54%	2.30	3 @ 1/2	152

NOTE: Operation at 50 Hz will generate approximately a 17% reduction in air performance.

See sheet EP-114 for amp draws/total load requirements.

MODEL NUMBER CONFIGURATION

CHD10-1 036 A A-R-SS

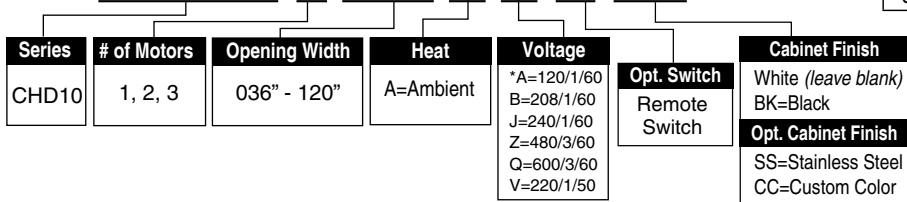

*Suitable for 50hz

for Standard offering, leave options (Opt.) blank
make sure to specify Cabinet Finish if other than white

Distance from Nozzle (in)	40	80	120	160	200
Core Velocity (fpm)	1270	1100	1000	940	910
Uniformity (%)	92	91	91	88	86

Sound level measured 10' (3m) from the unit in free field:	
1 motor:	Low/Medium/High Speed: 64/65/66 dBA
2 motors 60":	Low/Medium/High Speed: 66/67/68 dBA
2 motors:	Low/Medium/High Speed: 67/68/69 dBA
3 motors:	Low/Medium/High Speed: 67/68/69 dBA

Berner reserves the right to alter specifications without prior notice.



COMMERCIAL HIGH PERFORMANCE 10

Ambient (Unheated) Air Curtain
Electrical Performance Sheet

MODEL	120/1/60 (voltage code A) MOTOR AMP DRAW = 6.5 each			208/1/60 (voltage code B) MOTOR AMP DRAW = 3.5 each			240/1/60 (voltage code J) or 220/1/50 (voltage code V) MOTOR AMP DRAW = 3.5 each		
	# CKTS	AMPS PER CIRCUIT	BREAKER RATING PER CIRCUIT	# CKTS	AMPS PER CIRCUIT	BREAKER RATING PER CIRCUIT	# CKTS	AMPS PER CIRCUIT	BREAKER RATING PER CIRCUIT
CHD10-1036A CHD10-1042A CHD10-1048A CHD10-1060A	1	6.5	15	1	3.5	15	1	3.5	15
CHD10-2060A CHD10-2072A CHD10-2084A CHD10-2096A CHD10-2108A CHD10-2120A	1	13.0	20	1	7.0	15	1	7.0	15
CHD10-3096A CHD10-3108A CHD10-3120A	1	19.5	25	1	10.5	15	1	10.5	15

MODEL	480/3/60 (voltage code Z) MOTOR AMP DRAW = 1.4 each			600/3/60 (voltage code Q) MOTOR AMP DRAW = 1.0 each		
	# CKTS	AMPS PER CIRCUIT	BREAKER RATING PER CIRCUIT	# CKTS	AMPS PER CIRCUIT	BREAKER RATING PER CIRCUIT
CHD10-1036A CHD10-1042A CHD10-1048A CHD10-1060A	1	1.4	15	1	1.0	15
CHD10-2060A CHD10-2072A CHD10-2084A CHD10-2096A CHD10-2108A CHD10-2120A	1	2.8	15	1	2.0	15
CHD10-3096A CHD10-3108A CHD10-3120A	1	4.2	15	1	3.0	15

Berner reserves the right to alter specifications without prior notice.

www.berner.com **Berner International** 800.245-4455
111 Progress Ave. / New Castle / PA / 16101 / USA

EP-110
October, 2017

CHD 10 AMBIENT SYSTEM

TOP VIEW

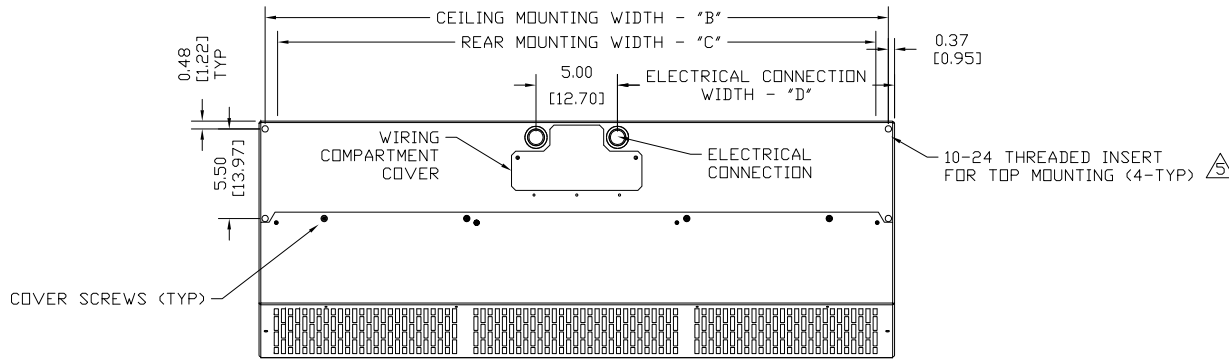

FRONT VIEW

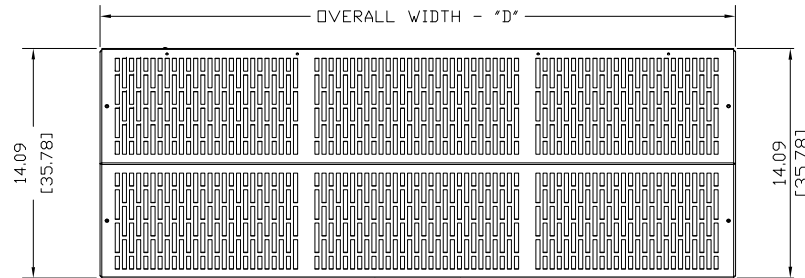

BOTTOM VIEW

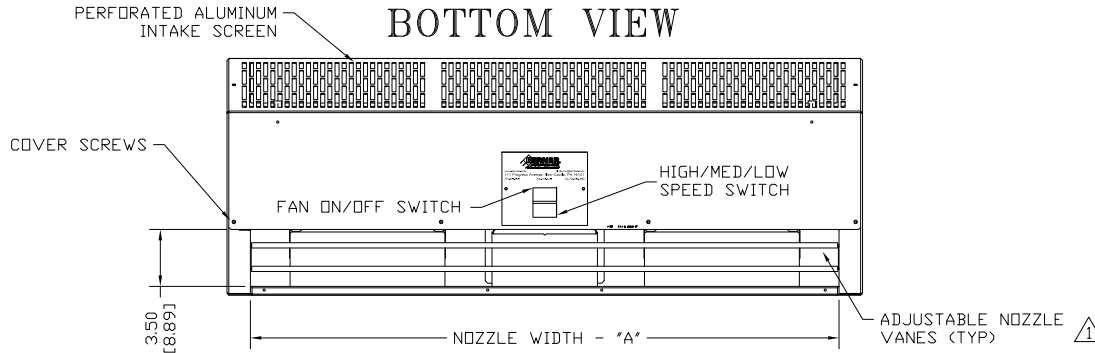

END VIEW

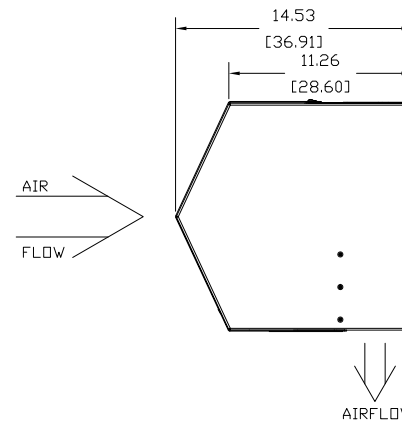

REAR VIEW

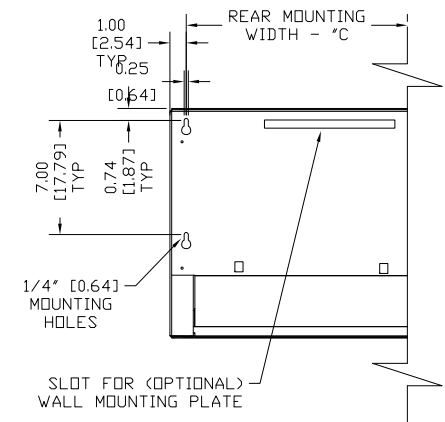

NOTES:

- ⚠ AIR CURTAIN MUST BE INSTALLED SO AIR STREAM IS NOT OBSTRUCTED WHEN DEFLECTED 20° TO EITHER SIDE OF \mathcal{C} .
- ⚡ ELECTRICAL CONNECTIONS TO BE FLEXIBLE.
- ⚠ FIELD VERIFY DIMENSIONS.
- ⚠ ANCHORS TO SUPPORTING STRUCTURE BY OTHERS.
- ⚠ ADEQUACY OF SUPPORTING STRUCTURE IS TO BE VERIFIED BY A PROFESSIONAL STRUCTURAL ENGINEER.
- ⚠ LETTER "A" IN MODEL NUMBER DESIGNATES AMBIENT UNIT.
- ⚠ DIMENSIONS IN INCHES [CENTIMETERS].

MODEL ⚠	NOZZLE WIDTH "A"	CEILING MOUNTING WIDTH "B"	REAR MOUNTING WIDTH "C"	UNIT WIDTH "D"	ELECTRIC WIDTH "E"
CHD10-1036A	36.00 [91.44]	38.25 [97.16]	37.00 [93.98]	39.00 [99.06]	17.00 [43.18]
CHD10-1042A	42.00 [106.68]	44.25 [112.40]	43.00 [109.22]	45.00 [114.30]	20.00 [50.80]
CHD10-1048A	48.00 [121.92]	50.25 [127.64]	49.00 [124.46]	51.00 [129.54]	23.00 [58.42]
CHD10-1060A	60.00 [152.40]	62.25 [158.12]	61.00 [154.94]	63.00 [160.02]	29.00 [73.66]
CHD10-2060A	60.00 [152.40]	62.25 [158.12]	61.00 [154.94]	63.00 [160.02]	19.00 [48.26]
CHD10-2072A	72.00 [182.88]	74.25 [188.60]	73.00 [185.42]	75.00 [190.50]	17.00 [43.18]
CHD10-2084A	86.88 [220.66]	89.13 [226.38]	87.88 [223.22]	89.88 [228.28]	20.75 [52.71]
CHD10-2096A	98.88 [251.14]	101.13 [257.18]	99.88 [253.70]	101.88 [258.76]	23.75 [60.33]
CHD10-3096A	98.88 [251.14]	101.13 [257.18]	99.88 [253.70]	101.88 [258.76]	15.50 [39.37]
CHD10-2108A	110.88 [281.62]	113.13 [287.38]	111.88 [284.18]	113.88 [289.24]	26.75 [67.95]
CHD10-3108A	110.88 [281.62]	113.13 [287.38]	111.88 [284.18]	113.88 [289.24]	17.50 [44.45]
CHD10-2120A	116.25 [295.28]	118.50 [300.99]	117.25 [297.82]	119.25 [302.90]	28.06 [71.28]
CHD10-3120A	116.25 [295.28]	118.50 [300.99]	117.25 [297.82]	119.25 [302.90]	18.38 [46.67]

PROJECT		
LOCATION		
ARCHITECT		
ENGINEER		REV. -
DWG. NO.	CHD10-AMB	TITLE: BERNER
DATE	25SEP2017	MODEL CHD10 AIR CURTAIN AMBIENT SYSTEM
BY	S. BEIL	
REPLACES	-	
BY	-	BERNER INTERNATIONAL CORP. NEW CASTLE, PA.